

Assembly Instruction For KING STORAGE FOOTBOARD/SLATS SR650KF



Caution: Please read instructions thoroughly before unpacking assembly parts. Sharp, exposed staple tips can cause injury, therefore, for your protection, please remove any exposed staples used in packing.

1. We recommend that you should assemble this product with the assistance of another person; this will make assembly easier, and will help to eliminate damage to the product or injury to persons during assembly.
2. Be sure to check all packing materials carefully for small parts that may have come loose inside the carton during shipment.
3. Please do not over tighten screws or bolts.
4. Please put all parts on a non-abrasive floor before assembly, and follow the assembly steps to assemble your newly purchased product correctly and efficiently.

PART LIST

NO.	PARTS DESC	Q'TY
A	KING DRAWER FRONT PANEL	2
B	KING DRAWER SIDE PANEL-LEFT	2
C	KING DRAWER SIDE PANEL-RIGHT	2
D	KING DRAWER BOTTOM PANEL	2
E	KING DRAWER BACK PANEL	2

HARDWARE LIST

NO.	HARDWARE DESC	CODE	Q'TY
1	 FB Storage Drawer Slide	PSR650F BSLD	4
2	 M3x10mm Screw		16
3	 M4x25mm Screw		24

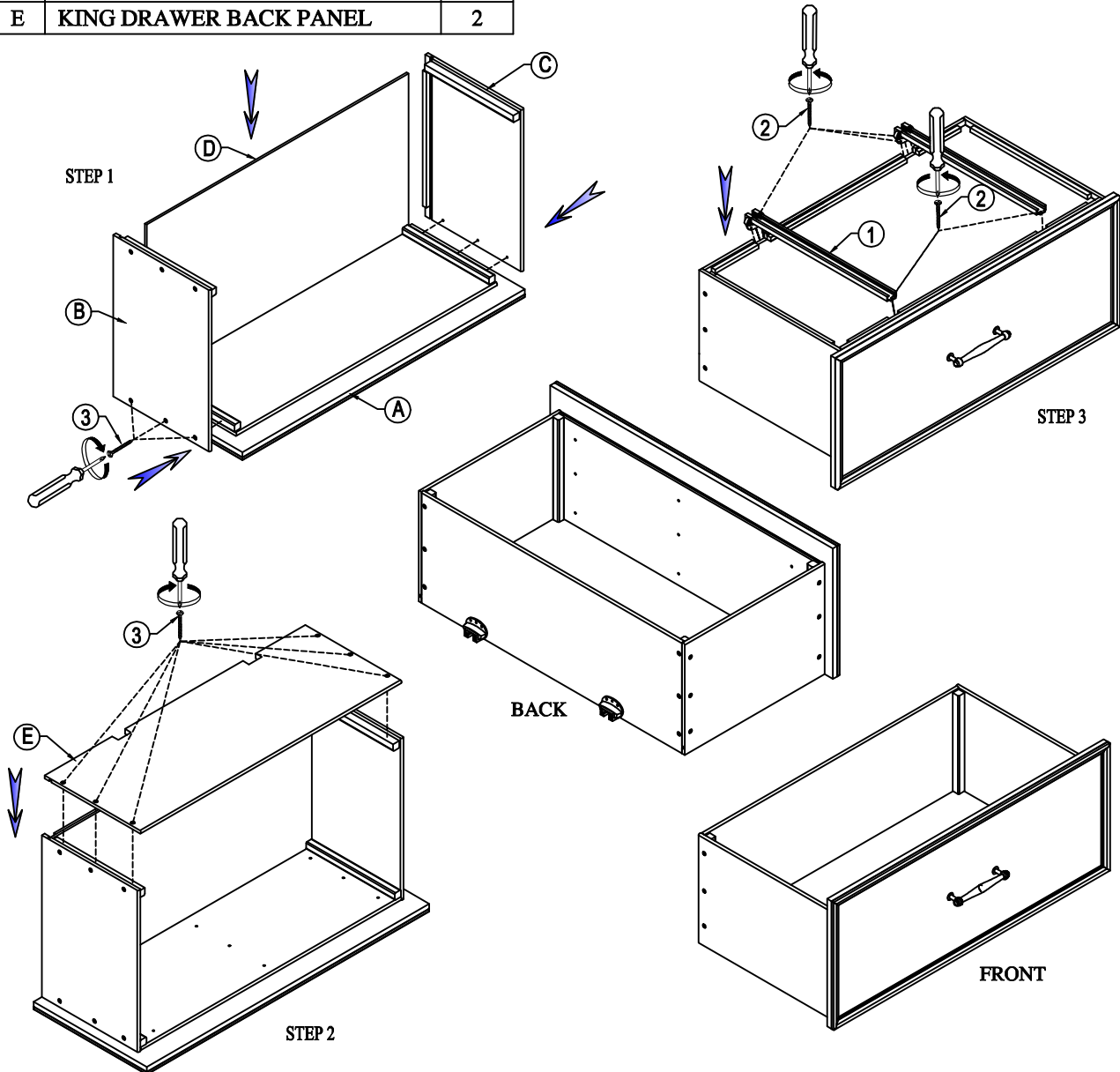

Assembly Instruction For

KING HEADBOARD

KING STORAGE FOOTBOARD/SLATS

QUEEN /KING STORAGE RAILS

SR600KH/SR650KF/SR650QKR

Caution: Please read instructions thoroughly before unpacking assembly parts. Sharp, exposed staple tips can cause injury, therefore, for your protection, please remove any exposed staples used in packing.

1. We recommend that you should assemble this product with the assistance of another person; this will make assembly easier, and will help to eliminate damage to the product or injury to persons during assembly.
2. Be sure to check all packing materials carefully for small parts that may have come loose inside the carton during shipment.
3. Please do not over tighten screws or bolts.
4. Please put all parts on a non-abrasive floor before assembly, and follow the assembly steps to assemble your newly purchased product correctly and efficiently.

PART LIST

NO.	PARTS DESC	CODE	Q'TY
A	KING HEADBOARD		1
B1	HEADBOARD LEFT LEG	PSR600HBLEG	1
B2	HEADBOARD RIGHT LEG	PSR600HBLEG	1
C	HEADBOARD STRETCHER	PSR600KHSTR	1
D	KING FOOTBOARD		1
E	FOOTBOARD BUN FEET	PSR650FDBFT	2

PART LIST

NO.	PARTS DESC	CODE	Q'TY
F	SIDE RAIL		2
G	DRAWER BACK SUPPORT RAIL	PSR650KFSLT	1
H	METAL GLIDE SUPPORT	PSR650FDSRL	4
I1	DRAWER SLAT SUPPORT	PSR650FDSPL	2
I2	BED SLAT SUPPORT	PSR650BDSPL	12
J	KING SLAT	PSR650KBSLT	1 SET
K	KING FOOTBOARD DRAWER	PSR650KFDRW	2

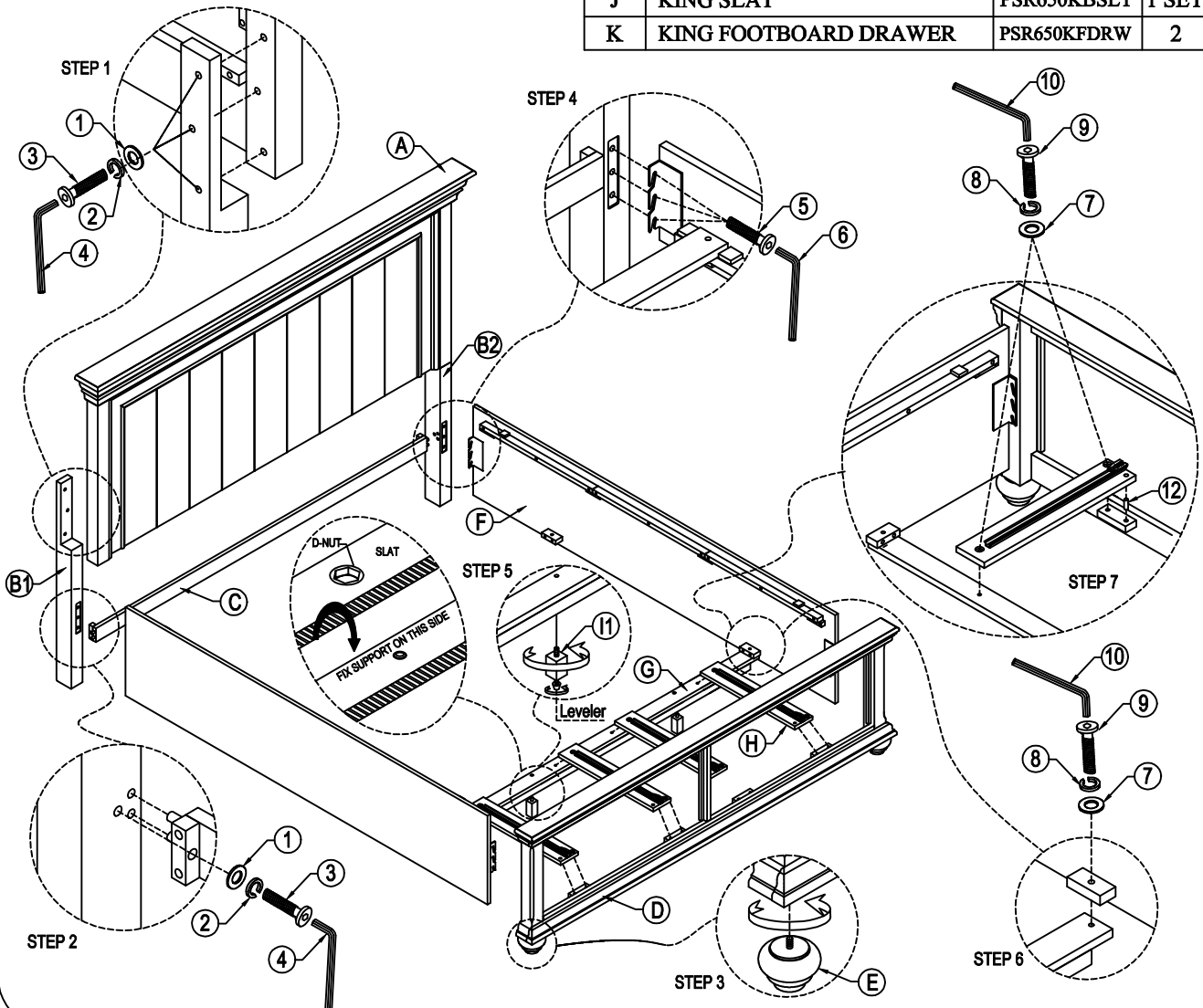

Assembly Instruction For

KING HEADBOARD





KING STORAGE FOOTBOARD/SLATS







QUEEN /KING STORAGE RAILS



SR600KH/SR650KF/SR650QKR

Caution: Please read instructions thoroughly before unpacking assembly parts. Sharp, exposed staple tips can cause injury, therefore, for your protection, please remove any exposed staples used in packing.

1. We recommend that you should assemble this product with the assistance of another person; this will make assembly easier, and will help to eliminate damage to the product or injury to persons during assembly.
2. Be sure to check all packing materials carefully for small parts that may have come loose inside the carton during shipment.
3. Please do not over tighten screws or bolts.
4. Please put all parts on a non-abrasive floor before assembly, and follow the assembly steps to assemble your newly purchased product correctly and efficiently.

NO.	Hardware List (packed with Headboard)		CODE	Q'TY
1		Flat Washer 5/16"	PSR600 KBHW	8
2		Spring Washer 5/16"		8
3		Bolt 5/16"		8
4		Allen Key M4		1

NO.	Hardware List (packed with Footboard)		CODE	Q'TY
7		Flat Washer 1/4"	PSR650 KBHW	10
8		Spring Washer 1/4"		10
9		Bolt 1/4"		10
10		Allen Key M4		1
11		Screw M4*25mm		26
12		Wooden dowel Ø10*30		4

NO.	Hardware List (packed with Siderails)		CODE	Q'TY
5		Bolt 5/16"	PSR600	12
6		Allen Key M4	KBHW	1

