



# ASSEMBLY INSTRUCTION FOR





## KING PANEL BED

### MC400KH / MC400KF / MC400QKR

Caution: Please read instructions thoroughly before unpacking assembly parts. Sharp, exposed staple tips can cause injury, therefore, for your protection, please remove any exposed staples used in packing.

1. We recommend that you should assemble this product with the assistance of another person; this will make assembly easier, and will help to eliminate damage the product or injury to persons during assembly.
2. Be sure to check all packing materials carefully for small parts that may have come loose inside the carton during shipment.
3. Please do not over tighten screws or bolts.
4. Please put all parts on a non-abrasive floor before assembly, and follow the assembly steps to assemble your newly purchased product correctly and efficiently.

PARTS LIST				
NO.	PART DESC.	PART	CODE	QTY
A	HEADBOARD		MC400KH	1 pc
B	HB - LEG (L / R)		PMC400HBLEG1	2 pcs
C	HB - STRETCHER		PMC400THSTR1	1 pc

HARDWARE LIST					
NO.	HARDWARE DESC.	PART	SIZE	CODE	QTY
1	ALLEN BOLT		M6 x 35mm	PMC400KBHW	4 pcs
2	ALLEN BOLT		M6 x 45mm		4 pcs
3	SPRING WASHER		M6		8 pcs
4	FLAT WASHER		M6 x 13mm		8 pcs
5	ALLEN KEY		M4		1 pc

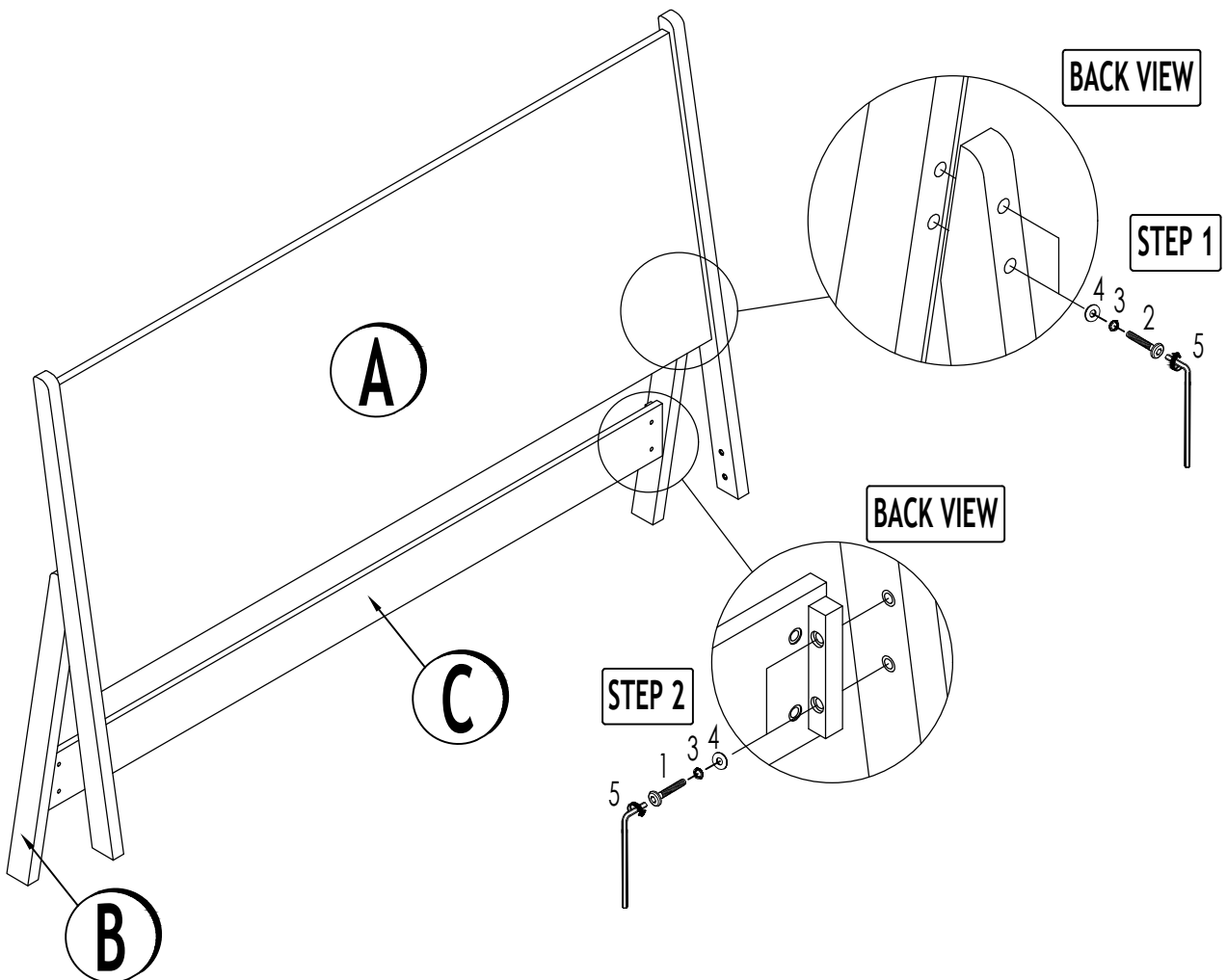







# ASSEMBLY INSTRUCTION FOR









## KING PANEL BED

### MC400KH / MC400KF / MC400QKR

Caution: Please read instructions thoroughly before unpacking assembly parts. Sharp, exposed staple tips can cause injury, therefore, for your protection, please remove any exposed staples used in packing.

1. We recommend that you should assemble this product with the assistance of another person; this will make assembly easier, and will help to eliminate damage the product or injury to persons during assembly.
2. Be sure to check all packing materials carefully for small parts that may have come loose inside the carton during shipment.
3. Please do not over tighten screws or bolts.
4. Please put all parts on a non-abrasive floor before assembly, and follow the assembly steps to assemble your newly purchased product correctly and efficiently.

PARTS LIST				
NO.	PART DESC.	PART	CODE	QTY
A	HEADBOARD		MC400KH	1 pc
B	FOOTBOARD		MC400KF	1 pc
C	SIDE RAIL ( L / R )		MC400QKR	2 pcs
D	SLAT ROLL ( 13 pcs )		PMC400KBSLT	1 set
E	CTR. RAIL		MC400QKR	1 pc
F	VERTICAL LEG		PMC400BDSPL1	4 pcs

HARDWARE LIST					
NO.	HARDWARE DESC.	PART	SIZE	CODE	QTY
1	ALLEN BOLT		M6 x 35mm	PMC400KBHW	4 pcs
2	SPRING WASHER		M6		4 pcs
3	FLAT WASHER		M6 x 13mm		4 pcs
4	ALLEN KEY		M4		1 pc
5	ALLEN BOLT		M8 x 20mm		8 pcs
6	FLAT WASHER		M8 x 18mm		8 pcs
7	ALLEN KEY		M5		1 pc
8	PANHEAD SCREW		M4 x 25mm		26 pcs

